

viscount

Prestige 80

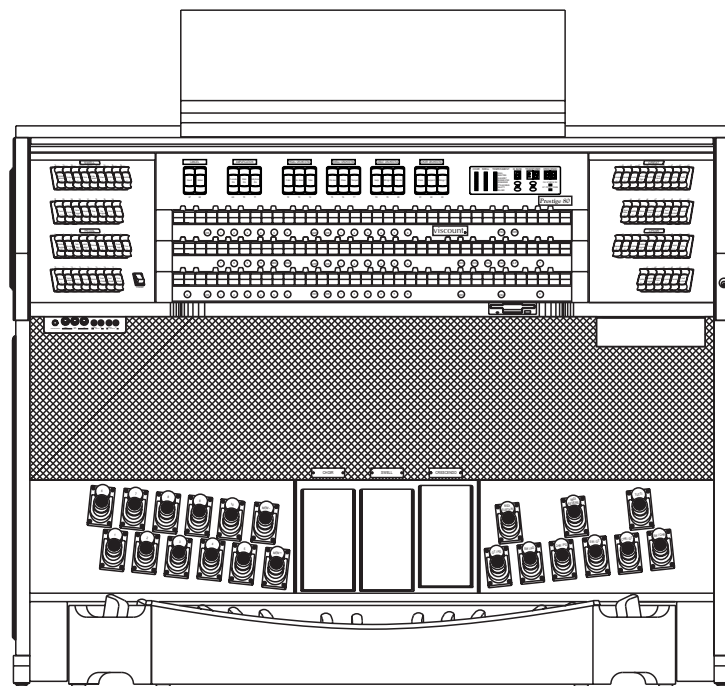

Quick Guide - USA

Ver. USA - 1.0

IMPORTANT SAFETY INSTRUCTIONS

WARNING: READ THIS FIRST!

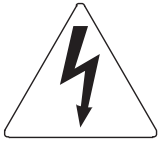

This symbol is intended to alert the user to the presence of uninsulated "dangerous voltage" within the product's enclosure that may be of sufficient magnitude to constitute a risk of electric shock to persons.



This symbol is intended to alert the user to the presence of important operating and maintenance (servicing) instructions in the literature accompanying the appliance.

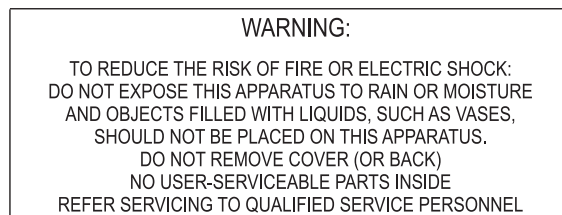

"INSTRUCTIONS PERTAINING TO A RISK OF FIRE, ELECTRIC SHOCK, OR INJURY TO PERSONS"

WARNING:

- 1) Read these instructions.
- 2) Keep these instructions.
- 3) Heed all warnings.
- 4) Follow all instructions.
- 5) Do not use this apparatus near water.
- 6) Clean only with dry cloth.
- 7) Do not block any ventilation openings. Install in accordance with the manufacturer's instructions.
- 8) Do not install near any heat sources such as radiators, heat registers, stoves, or other apparatus (including amplifiers) that produces heat.
- 9) Do not defeat the safety purpose of the polarized or grounding-type plug. A polarized plug has two blades with one wider than the other. A grounding type plug has two blades and a third grounding prong. The wider blade or the third prong are provided for your safety. If the provided plug does not fit in to your outlet, consult an electrician for replacement of the obsolete outlet.
- 10) Protect the power cord from being walked on or pinched, particularly at plugs, convenience receptacles, and the point where they exit from the apparatus.
- 11) Only use attachments/accessories specified by the manufacturer.
- 12) Use only with the cart, stand, tripod, bracket, or table specified by the manufacturer, or sold, with the apparatus. When a cart is used, use caution when moving the cart/apparatus combination to avoid injury from tip-over.
- 13) Unplug this apparatus during lightning storms or when unused for long periods of time.
- 14) Refer all servicing to qualified service personnel. Servicing is required when the apparatus has been damaged in any way, such as power-supply cord or plug is damaged, liquid has been spilled or objects have fallen into the apparatus, the apparatus has been exposed to rain or moisture, does not operate normally, or has been dropped.



NOTE: The socket-outlet shall be installed near the equipment and shall be easily accessible.

SAVE THESE INSTRUCTIONS

CONTENTS

| | |
|---|-----------|
| 1. Important notes | 3 |
| 1.1 Looking after the product | 3 |
| 1.2 Notes on floppy disks | 3 |
| 1.3 Notes about the manual | 4 |
| 2. Controls and connections | 5 |
| 2.1 The side panels | 5 |
| 2.2 The central panel | 6 |
| 2.3 The controls for the manuals thumb pistons | 7 |
| 2.4 Pedalboard controls | 10 |
| 2.5 Connections underneath the manuals | 11 |
| 2.6 Input / Output connections panel | 12 |
| 2.7 The remote control (optional) | 14 |
| 3. Central control unit | 15 |
| 4. Organ general settings | 18 |
| 4.1 Setting the tremolo | 19 |
| 4.2 Selecting the type of reverb | 19 |
| 4.3 General settings for the manuals | 20 |
| 5. Recording and playing back musical performances | 22 |
| 5.1 Recording a performance | 22 |
| 5.2 Playing back a performance | 23 |
| 6. Voices local off | 24 |
| 7. Factory Setting | 24 |

1. IMPORTANT NOTES

1.1 LOOKING AFTER THE PRODUCT

- Do not apply excessive force to the organ's structures or the controls (knobs, stops, push-buttons, etc.).
- When possible, do not place the instrument close to units which generate strong interference, such as radios, TVs, computer videos, etc.
- Do not place the organ close to heat sources, in damp or dusty places or in the vicinity of strong magnetic fields.
- Do not expose the instrument to direct sunlight.
- Never insert foreign bodies inside the instrument or pour liquids of any kind into it.
- For cleaning, use only a soft brush or compressed air; never use detergents, solvents or alcohol.
- Always use good quality screened cables for connection to amplification or diffusion systems. When disconnecting cables from sockets, always take hold of the connector and not the cable itself; when winding cables, do not knot or twist them.
- Before making the connections ensure that the other units (especially amplification and diffusion systems) you are about to connect are switched off. This will prevent noisy or even dangerous signal peaks.
- If the organ is to be out of use for lengthy periods, disconnect the plug from the power socket.

1.2 NOTES ON FLOPPY DISKS

- Use only good quality floppy disks.
- Do not extract the floppy disk when reading or writing operations are in progress (when the LED on the drive is on); this may damage the head and the magnetic medium.
- Use only 3.5" DD and HD (720Kbyte and 1.44Mbyte) floppy disks formatted to the MS-DOS standard.
- Take good care of your floppy disks and do not place them close to heat sources or magnetic fields (computer videos, loudspeakers, etc.), or in damp or dusty places.
- The manufacturer does not accept any liability for damage to the floppy disk drive in case of use of damaged floppy disks.

1.3 NOTES ABOUT THE MANUAL

- Take good care of this manual.
- This manual is an integral part of the instrument. The descriptions and illustrations in this publication are not binding.
- While the instrument's essential characteristics remain the same, the manufacturer reserves the right to make any modifications to parts, details or accessories considered appropriate to improve the product or for requirements of a constructional or commercial nature, at any time and without undertaking to update this publication immediately.
- All rights reserved; the reproduction of any part of this manual, in any form, without the manufacturer's specific written permission is forbidden.
- All the trademarks referred to in this manual are the property of the respective manufacturers.
- Please read all the information carefully, so that you obtain the best performance and will from your instrument.
- The codes or numbers in square brackets ([]) indicate the names of the buttons, sliders, trimmers and connectors on the instrument. For example, [ENTER] refers to the ENTER button.
- The illustrations and display pages are purely guideline and may differ from those actually shown on the display.

2. CONTROLS AND CONNECTIONS

2.1 THE SIDE PANELS

LEFT PANEL

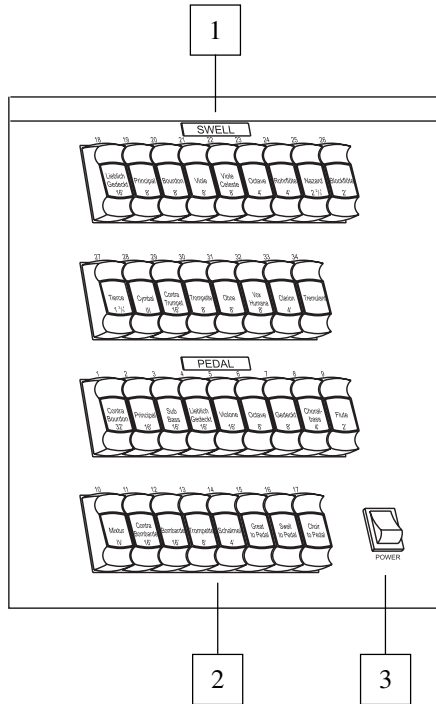

1. **[SWELL] stops:** this section contains the stops of Swell voices.
2. **[PEDAL] stops :** this section contains the voices of the pedal board and the couplers.
 - **[Great to Pedal]:** the voices of Great will also play on the pedal board.
 - **[Swell to Pedal]:** the voices of Swell will also play on the pedal board.
 - **[Choir to Pedal]:** the voices of the Choir will also play on the pedal board.
3. **[POWER] switch:** in order to switch the instrument on and off.

RIGHT PANEL

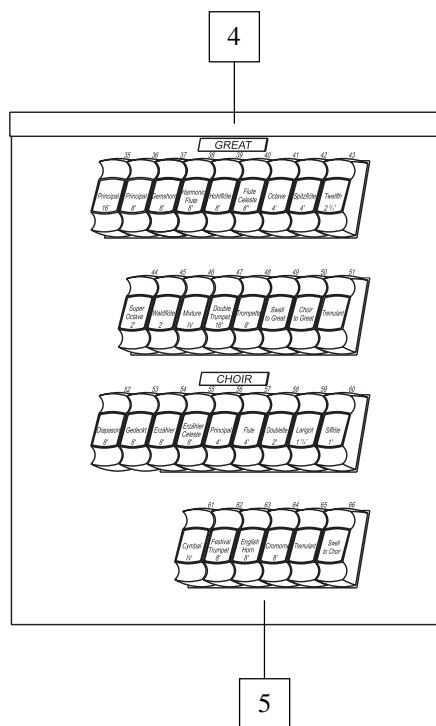

4. **[GREAT] stops:** these stops can be used to activate the voices of Great on and off. This section also contains the following couplers:
 - **[Swell to Great]:** the voices of Swell will also play on Great.
 - **[Choir to Great]:** the voices of the Choir will also play on Great.
5. **[CHOIR] stops:** this section contains the stops of Choir as well as the couplers.
 - **[Swell to Choir]:** the voices of Swell will also play on Choir.

NOTE

The couplers do not work with the Orchestra voices.

2.2 THE CENTRAL PANEL

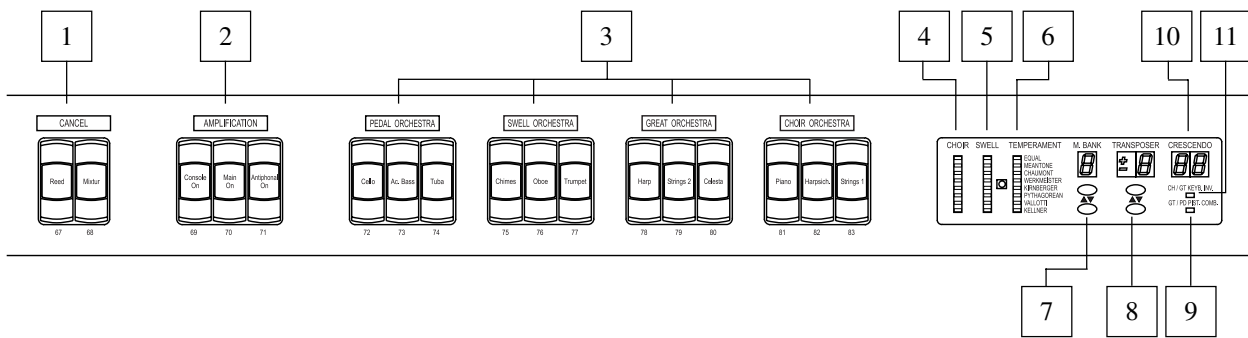

1. **CANCEL section:** these controls can be used to exclude all of the reeds ([REED]) and/or mixtures ([MIXTURE]).
2. **AMPLIFICATION section:** these three controls can be used to activate or deactivate the organ amplification, more specifically:
 - [CONSOLE ON]: controls the organ’s internal amplification.
 - [MAIN ON]: controls the rear outputs [MAIN OUT].
 - [ANTIPHONAL ON]: controls the rear outputs [ANTIPHONAL OUT].
3. **ORCHESTRA Section:** this section contains the organ’s Orchestra voices. One of the most important feature of the Prestige 80 is the Orchestra section, which can be added to the organ voices, enhancing the organ’s voice range. The buttons are divided into four sections:
 - [PEDAL ORCHESTRA]: pedal board voices.
 - [SWELL ORCHESTRA]: voices of the Swell.
 - [GREAT ORCHESTRA]: voices of the Great.
 - [CHOIR ORCHESTRA]: voices of the Choir.

To select voices other than the default ones and to change the internal parameters please refer to the “Advanced Manual”.

4. [CHOIR] LED bar: shows the position of the [CHOIR] expression pedal.
5. [SWELL] LED bar: shows the position of the [SWELL] expression pedal.
6. [TEMPERAMENT] LED bar: shows the temperament currently selected by means of the central control unit located in the drawer under the manuals (for more information see chap. 3).
7. [M. BANK] selector: in order to select one of the eight memory banks for memorizing general and/or dedicated memories. Thus you will have in total 80 general and 192 dedicated memories. This feature is particularly useful in case the instrument is used by more than one organist, as each will be able to save his setting in a different Memory Bank.
8. [TRANSPOSER] selector: sets the instrument’s tuning within a range of +5 / -6 semitones (adjustments in steps of one semitone).

9. [GT/PD PIST. COMB.] LED: LED which displays the status of the GREAT / PEDAL PISTON COMBINE function. When the function is enabled (LED on), the pedal board memories are “coupled” to those of the Great. In this way when a memory dedicated to the Great is activated, automatically the same memory is recalled for the pedal board.

For how to activate this function, see par. 4.3.

10. [CRESCENDO] LED bar: these LEDs display the step of the Crescendo currently set with the pedal of the same name.

11. [CH/GT KEYB. INV.] LED: LED displaying the status of the CHOIR/GREAT KEYBOARDS INVERSION function, which enables the positions of Great and Choir to be inverted (LED on). To set the function, refer to par. 4.3.

2.3 THE CONTROLS FOR THE MANUAL THUMB PISTONS

SWELL

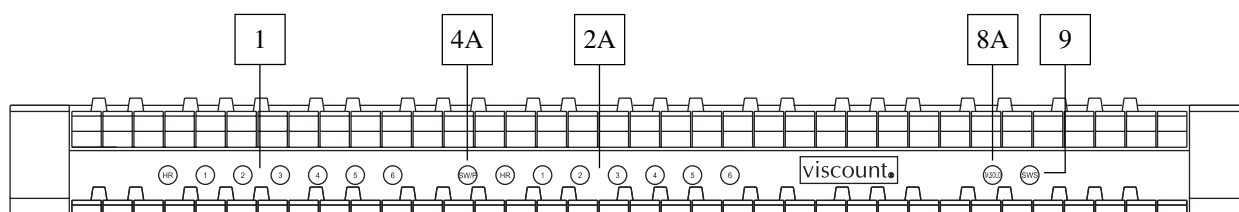

GREAT

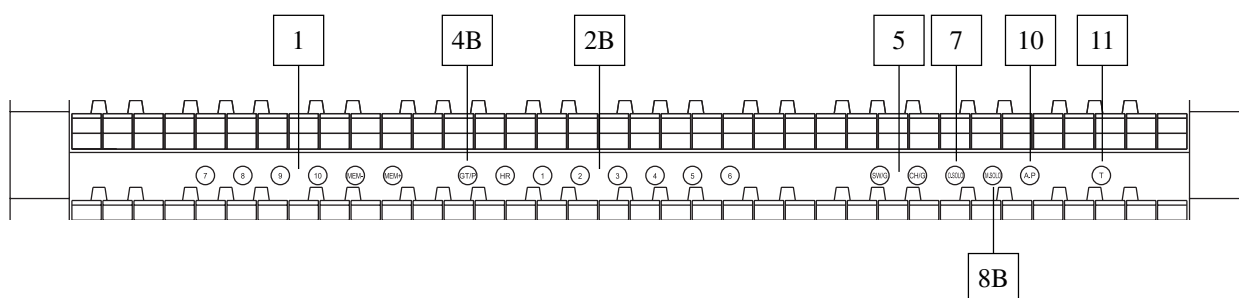

CHOIR

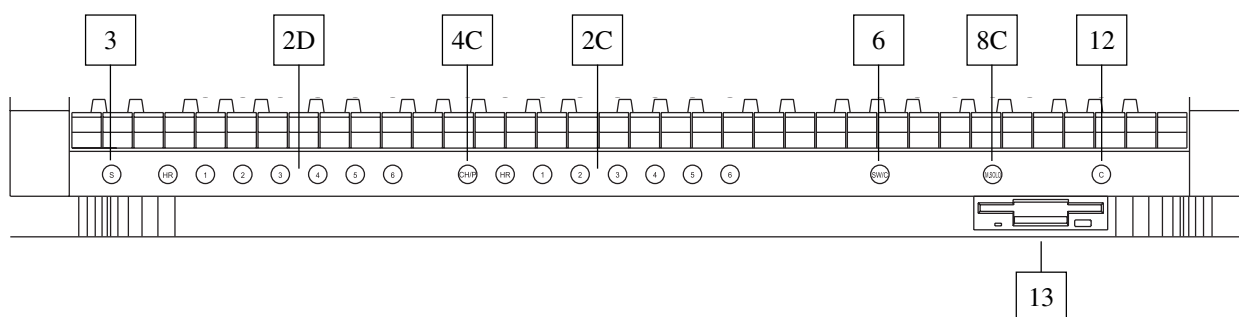

1. General memories: this section contains the instrument’s general memories. The [MEM+] buttons can also be used to select the individual memories in ascending order and [MEM-] to recall them in descending order.

- 2. Dedicated memories:** the Prestige 80 memories also include six dedicated memories for Swell (2A), Great (2B), Choir (2C) and the pedal board (2D). In the dedicated memories it is only possible to save **the set up of the section coupled to the selected memory**.

The memories also include an [HR] button, also known as 0, which recalls the set up that was present before a memory was activated. The contents of [HR] are not affected by calling up a memory when another one has previously been activated.

In each memory, whether general or dedicated memory, the following can be saved

- the voices (including Orchestra)
- the couplers
- the tremolo effects (also with different speed and depth by activating this function on menu Set-Up, see par. 4.3)
- the MIDI To controls (par.3), MIDI Solo (point 8 of this paragraph) and Program Change set using the SEND PROGRAM CHANGE function (“Advanced Manual”)

Only in the general memories is it also possible to save:

- the Organ Solo
- the All Swells on Swell and Automatic Pedal (by activating the relevant function, see par. 4.3)

For the memory saving procedure, see point 3.

- 3. [S] button:** “Set” button which enables memory saving. To save a memory, simply press the [S] button and, keeping it pressed down, then press the button of the memory you wish to save, whether it is dedicated or general.
- 4. Pedal couplers buttons:** these buttons activate the couplings of the manuals with the pedal board, as follows:
- [SW/P] (4A): coupling the Swell with the pedal board.
 - [GT/P] (4B): coupling the Great with the pedal board.
 - [CH/P] (4C): coupling the Choir with the pedal board.
- 5. Great couplers:** these buttons activate the couplings with Great, as follows:
- [SW/G]: coupling the Swell with the Great.
 - [CH/G]: coupling the Choir with the Great.
- 6. [SW/C] button:** this button enables the coupling of the Swell with the Choir.

NOTE

The couplers do not work on the Orchestra voices.

- 7. [O.SOLO] button:** this button controls the status of the Organ Solo function. By activating this function **plus the coupling SW/GT** the voices of the Swell can be played on the Great in monophony with priority given to the highest note. On the Swell the voices continue to sound in polyphony.

8. **[M.SOLO] button:** these buttons control the status of the MIDI Solo function for Swell (8A), Great (8B) and Choir (8C). By activating this function, on the instrument connected to the [MIDI OUT] port only the highest note of those pressed down will sound (monophony with priority given to the highest note).

NOTE

The monophonic notes generated by the MIDI Solo are only sent on MIDI channel B. For a detailed description of the MIDI channels controlled by the organ see the "Advanced Manual".

9. **[SWS] button:** this button allows to control the organ's general volume by means of the [SWELL] pedal.
10. **[A.P.] button:** this button enables the Automatic Pedal, used to play the voices of the pedal board using the first 32 notes of Great. In this case, the organ pedal board is deactivated and the voices become monophonic, with priority given to the lowest note.
11. **[T] button:** "Tutti" button, which turns on a preset series of voices and couplers.

The voice composition of the 'Tutti' function is programmable. To save a new set up, switch on the voices and couplers of your choice, press [S] and, keeping it pressed down, then press button [T] or the [TUTTI] foot piston.

12. **[C] button:** "Cancel" button, which switches off any voices, couplers and buttons on the manual divisionals which may be on and turns the HR buttons on.
13. **Floppy disk drive:** use only 720 Kb or 1.44 Mb 3.5" floppy disks.

NOTE

The Automatic Pedal and All Swells to Swell will not be turned off by the Cancel button if saving these two controls programmed in the general memories (see also par. 4.3).

2.4 PEDAL BOARD CONTROLS

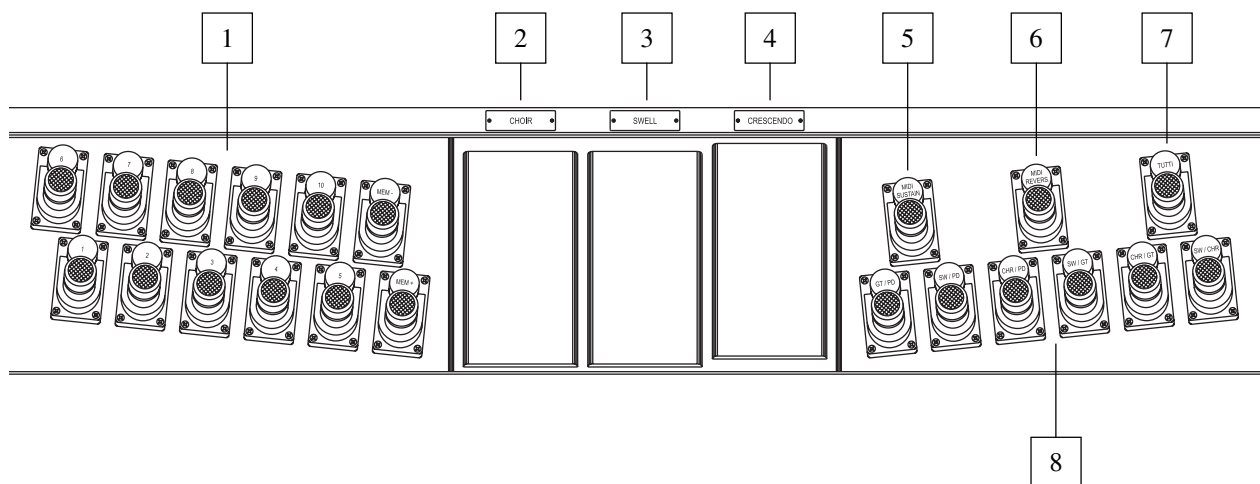

1. **General memory pistons:** these pistons can be used to recall the organ general memories. There are also the [MEM+] and [MEM-] pistons to select the memories in ascending and descending order.
2. **[CHOIR] pedal:** expression pedal used to control the volume of the Choir.
3. **[SWELL] pedal:** this expression pedal is used to control the volume of the Swell.
4. **[CRESCENDO] pedal:** this pedal can be used to select the Crescendo steps which activate a preset series of stops. The step currently selected is displayed by the [CRESCENDO] LED bar on the centre panel (see also point 11 of par. 2.2).

Each Crescendo step is programmable. To do this, use the [CRESCENDO] pedal to select the step required, switch on the voices and couplers needed, press button [S] and, keeping it pressed down, then press the general memories [HR] button.

5. **[MIDI SUSTAIN] piston:** Sustain piston of the **Orchestra voices** and by which CC64 is sent to the [MIDI OUT].
6. **[MIDI REVERSIBLE] piston:** cancels the current MIDI To settings to allow a new set up. By deactivating MIDI Reversible, the MIDI To settings will revert to how they were before the piston was turned on.
7. **[TUTTI] piston:** the piston used to activate the Tutti. For a more detailed description, refer to point 11 of par. 2.3.
8. **Coupler pistons:** these pistons activate the organ couplings described in par. 2.1 and/or 2.3.

2.5 CONNECTIONS UNDERNEATH THE MANUALS

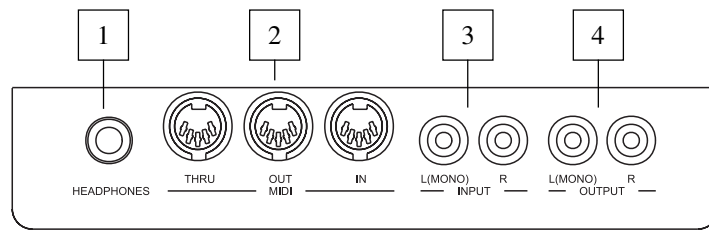

1. **[HEADPHONES] socket:** Jack socket to which a headphone set can be connected. With headphones connected, the organ's internal amplification is cut off.

NOTE

For optimum performance from the [HEADPHONES] output it is recommended that headphones with a minimum impedance of 16Ω be used.

2. **[MIDI] sockets:** five-pin DIN plugs for connecting instruments with MIDI interface. The [IN] connector allows receipt of MIDI messages generated by remote MIDI sources, the [OUT] connector sends the MIDI messages generated by the Prestige 80, and the [THRU] connection sends exactly the same data received at the [IN] connector.

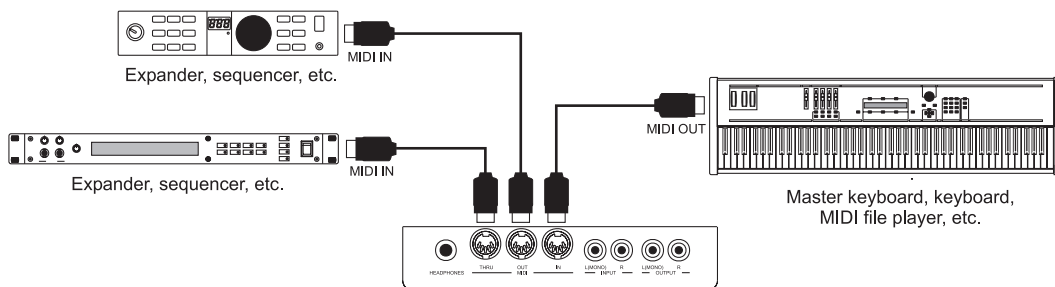

3. **[INPUT] sockets:** RCA input sockets which allow other instruments to be played using the organ's internal amplification. If the source is monophonic use the L(MONO) connector only.
4. **[OUTPUT] sockets:** RCA sockets to output the non-amplified signal, for connecting optional amplified speakers, remote amplification systems or recording systems. For monophonic signals connect to the [L/(MONO)] socket only.

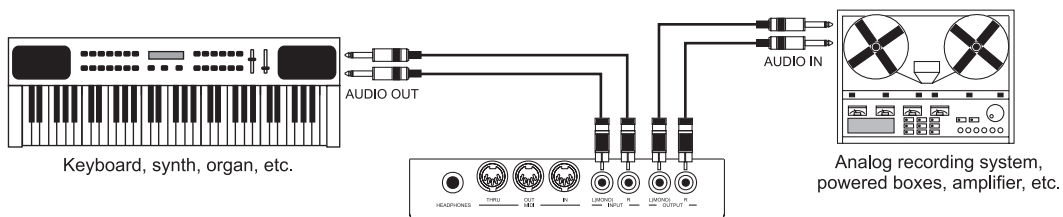

2.6 INPUT / OUTPUT CONNECTIONS PANEL

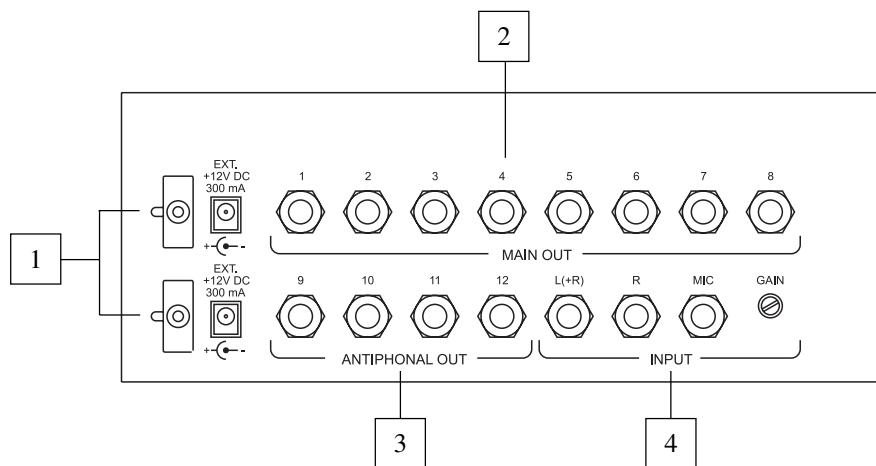

Internal connections by qualified service person only.

1. **[EXT. +12V DC] connectors:** these sockets can be used to obtain the +12V DC voltage needed to supply the VISCOUNT speakers connected to the [MAIN OUT] sockets and/or the [ANTIPHONAL OUT].

2. **[MAIN OUT] Section:** this section contains eight line outputs, that can be activated by the [MAIN ON] stop on the centre panel (point 2 of par. 2.2), to which a maximum of eight speakers can be connected for external organ amplification.

By means of the internal set up functions, which can be called up using the central control unit, it will also be possible to edit various parameters for these audio outputs (individual volumes, delays and equalisations) and to set these outputs in such a way as to simulate the wind chests of the original church organs. These functions called EXTERNAL OUTPUTS CONTROL and EXTERNAL VOICES ROUTER are described in the “Advanced Manual”.

WARNING!

- Pay particular attention to the fact that a non connected [MAIN OUT] socket also disables the next ones. This means that if socket [6] is not connected, sockets [7] and [8] will not work either.
- In order to reach a proper pipes simulation, you have to locate the speakers boxes according to the output numbers. The speaker box connected to output [1] has to be located on the extreme left followed by all other speakers connected to outputs [2], [3] and [4] so that the last speaker box connected to output [8] will be located to the extreme right.

3. **[ANTIPHONAL OUT] section:** This section contains four line outputs that can be activated by the [ANTIPHONAL ON] stop on the centre panel (point 2 of par. 2.2).

The signals are divided among the four outputs according to the settings in the SET-UP menu (ANTIPHONAL OUTPUTS SETTING function), of the internal amplification (VOICES ADJUST function) and the distribution of the individual voice on the external outputs (EXTERNAL VOICES ROUTER function).

All these functions are fully described in the “Advanced Manual”.

4. **[INPUT] section:** this section contains the inputs through which the output signal of external equipment is amplified with the organ’s internal amplification system. The connections are as follows:

- **[L(+R)], [R]:** stereo line inputs for connecting instruments with line outputs. For mono sources use only the socket [L(+R)].
- **[MIC]:** Microphone input for amplifying any signal coming from a microphone.
- **[GAIN]:** trimmer for adjusting the input signal connected to the [MIC] input.

NOTE

The volume controls for the manuals, the pedal board and the Orchestra voices are in the drawer under the keyshelf (see also par. 3), as well as the [CHOIR] and [SWELL] swell pedals (par. 2.4) also affect the levels of the audio output signals [MAIN OUT] and [ANTIPHONAL OUT] found on the back panel and [OUTPUT] in the drawer under the manuals. The only control that does not affect these outputs is the [GENERAL] trimmer.

EXAMPLE OF OUTPUT CONNECTIONS

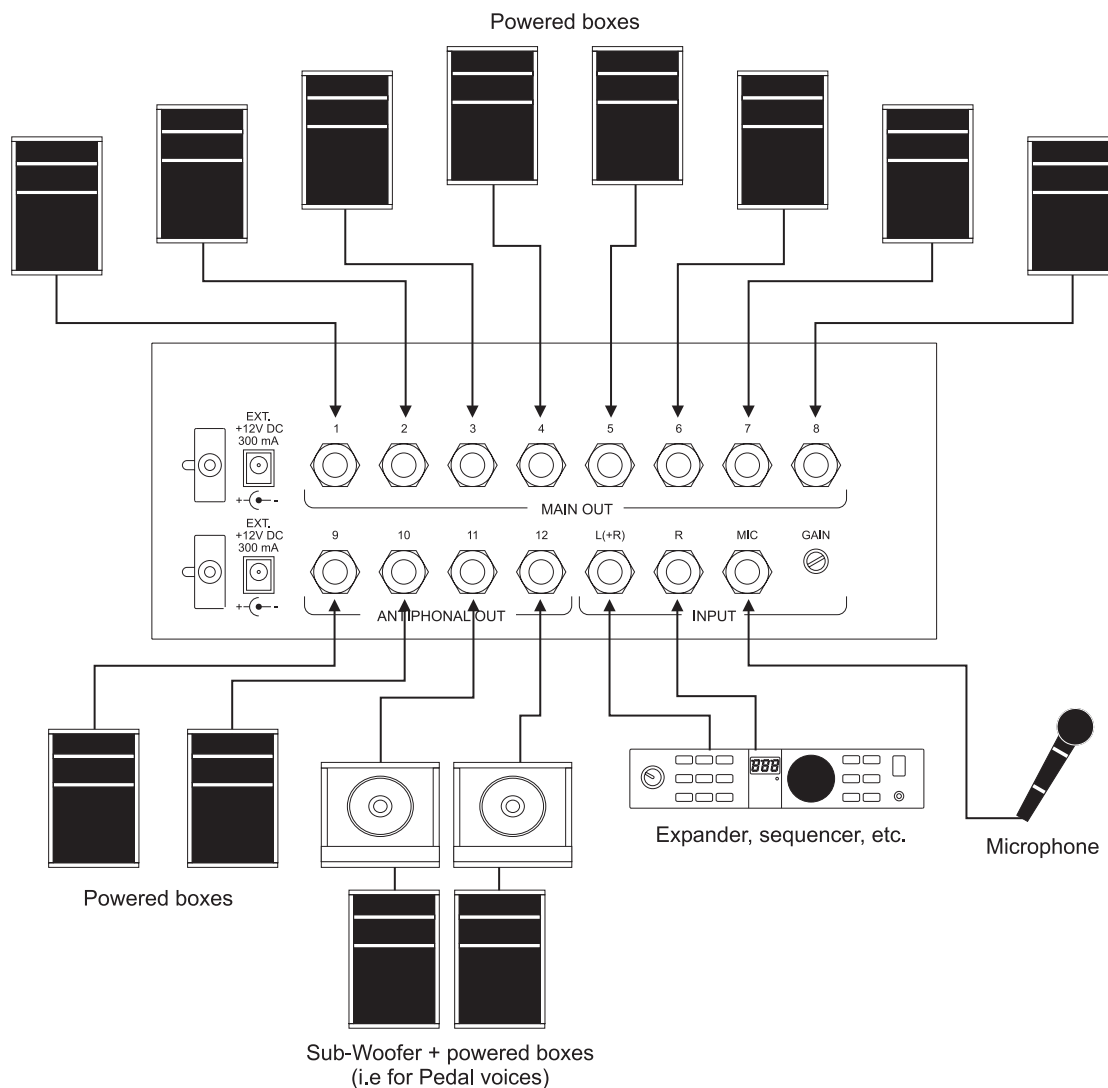

2.7 THE REMOTE CONTROL (OPTIONAL)

The Prestige 80 can be equipped with a radio remote control which can be used to control the general volume of the organ and the main sequencer functions at a distance. Refer to your dealer to purchase this device.

The button functions are:

1. **[START-STOP]:** press repeatedly to start / stop recording / playback the MIDI sequence.
2. **[PAUSE]:** stops the MIDI sequence temporarily during playback.
3. **[AUTO PLAY SONG]:** these six buttons can be used to playback automatically the first six MIDI backing tracks saved on the floppy disk, without the need to press the [START-STOP] button to start playback.
4. **[SONG]:** these two buttons can be used to select the MIDI sequences on the floppy disk.
5. **[VOLUME]:** buttons for adjusting the general volume of the organ.

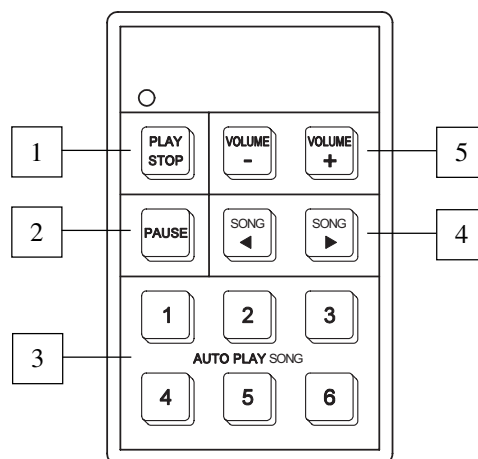

NOTE

The Led on the START –STOP switch indicates the datas transmission of the remote control. In case of flashing, please replace the batteries located inside the remote control.

REPLACEMENT OF THE BATTERIES

Remove the screw located on the back of the remote control, carefully remove the plastic cover and replace the batteries in the proper place (Do not invert the polarity – see picture below)

ATTENTION – use only CR1220 3 Volts Lithium batteries

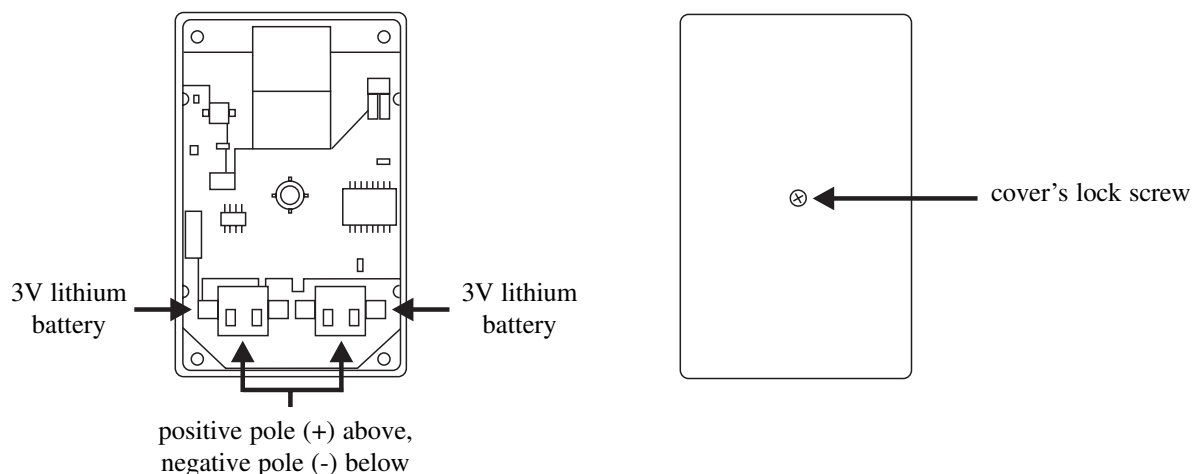

3. CENTRAL CONTROL UNIT

The drawer located under the keyshelf contains the central control unit for all the internal functions of the Prestige 80. This “Quick Guide” describes the basic functions of this system, for a detailed description of all the remaining functions and parameters please see the “Advanced Manual”.

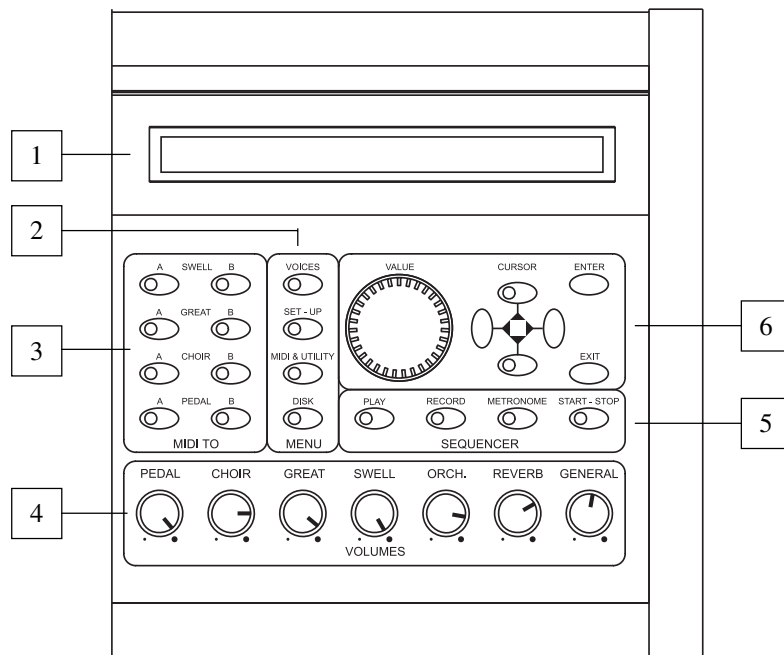

1. **Display:** 40-characters display on two lines showing all the pages relating to the organ’s functions.
2. **Menu selection buttons:** these buttons are used to select the four main display function menus, as follows:
 - **[VOICES]** (described in the “Advanced Manual”): menu of the main functions relating to the organ voices.
 - **[SET-UP]** (chap. 4): general functions for organ settings.
 - **[MIDI & UTILITY]** (described in the “Advanced Manual”): settings for MIDI interface and the rear outputs.
 - **[DISK]** (described in the “Advanced Manual”): functions relating to floppy disks and the files saved in them.
3. **MIDI TO section:** this section contains the buttons used to activate transmission of the MIDI note codes on channels A and B of each manual and the pedal board. The LED for each button shows the transmission status on the relative MIDI channel according to the rule:
 - LED on: transmission of note codes enabled:
 - LED off: transmission of note codes disabled:

For further information about the organ’s MIDI interface capabilities, see the “Advanced Manual”.

4. VOLUMES section: these controls are used to adjust the individual volumes of the organ, as follows:

- **[PEDAL]:** pedal board volume.
- **[CHOIR]:** volume of the Choir.
- **[GREAT]:** volume of the Great.
- **[SWELL]:** volume of the Swell.
- **[ORCH.]:** volume of the Orchestra voices.
- **[REVERB]:** regulates the level of the reverb effect.
- **[GENERAL]:** the general volume of the organ.

5. Sequencer: this section contains the buttons for operating the multitrack sequencer incorporated into the Prestige 80.

The basic functions of the sequencer are described in chap. 5 of this “Quick Guide”, while a complete description of all the functions can be found in the “Advanced Manual”.

- **[PLAY]:** this button is used to playback the MIDI sequences recorded
- **[RECORD]:** button for starting a recording session.
- **[METRONOME]:** when pressed quickly activates the audio metronome; when held down for a few moments it calls up the metronome setting page.
- **[START-STOP]:** starts / stops recording or playback of the MIDI sequence.

6. Display function control buttons: these buttons are used to move the cursor (indicated by a flashing field on the display), to set values, to select pages and to confirm or reject prompts from the system.

- **[VALUE]:** rotary encoder for setting parameters.
- **CURSOR [▲], [▼], [◀], [▶]:** these buttons are used to move the cursor within the page on the screen. The [▲] and [▼] buttons are additionally equipped with LEDs which, when illuminated, signal respectively the presence of a subsequent and/or previous page to the one currently showing. Press the appropriate button to see the page required:
- **[ENTER]:** button for displaying the content of functions or for confirming any prompts that may appear on the display.
- **[EXIT]:** button for exiting the current page or for rejecting any system prompts.

Some seconds after the switching on of the instrument, the display will show:

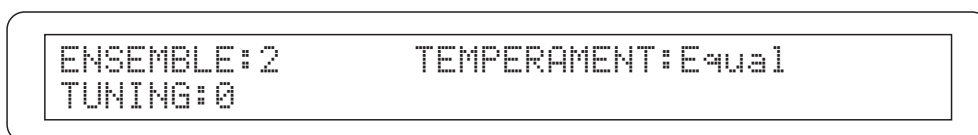

containing the following parameters:

- **ENSEMBLE:** using this parameter it is possible to set eight levels of natural slight lack of intonation between one pipe and another in order to simulate the imperfect tunings of organ pipes caused in time by wear and temperature.
This parameter works according to the general organ tuning, adjusted using the Transposer and the Tuning heading found on this page, the temperament selected and the number of voices on. The values range from – (pipes perfectly in tune) to **8** (maximum lack of intonation).

- **TEMPERAMENT:** this parameter provides a selection of historical temperaments from various ages and different national origin. A perfectly tuned **EQUAL** temperament can be selected, or alternatively the classic **MEANTONE, CHAUMONT, WERCKMEISTER, KIRNBERGER, PYTHAGOREAN, VALLOTTI** and **KELLNER**.
- **TUNING:** allows adjustment of the fine tuning of the instrument within a range of ± 50 hundredths of a semiton.

A BRIEF NOTE ON TEMPERAMENTS

*In the “natural” tuning system, based on the acoustic phenomenon of harmonic voices, two important musical intervals, the major third and the perfect fifth, cannot be made to coexist in the “pure” state (i.e. beat-free). Therefore, over the centuries a variety of compromise solutions known as **TEMPERAMENTS** have been invented and realised.*

These give the priority to one interval or the other, and modify them in various ways..

In ancient times and in the Middle Ages, until the end of the 15th Century, the “Pythagorean” tuning system, in which the fifths were kept perfectly pure, was used. The resulting major third interval was particularly unpleasant and was therefore considered a dissonance. However, the music of the time was mainly monodic and the first vocal and instrumental polyphonic forms made wide use of the interval of a fifth. With the early Renaissance and the start of the great age of vocal polyphony, the interval of a major third gradually came to be heard as a consonance. The instruments with fixed tuning, such as the organ and harpsichord, were adapted to this situation by using a system of temperament known as meantone, which gave priority to the major third over the fifth. This temperament is particularly important since it was in normal use in Europe in the 16th and 17th Centuries, until the beginning of the 18th. Here are the six temperaments offered by the Prestige 80, first of all the MEANTONE.

MEANTONE

- 8 pure major thirds: E flat – G / B flat – D / F – A / C – E / G – B / D – F # / A – C # / E – G.
- 4 unusable major thirds (diminished fourths): B – D # / F # - A # / C # - E # / A flat - C.
- 1 fifth known as the “wolf” (very dissonant extended fifth): G # - E flat.
- Highly irregular chromatic scale (meaning that chromatic compositions are given a very distinctive voice)
- Keys usable with this temperament: C maj. / D maj. / G maj. / A maj. / B flat maj. and the relative minors.

The temperaments which follow allow all the major and minor keys to be used, although those with the most alterations have a highly distinctive voice, in contrast with the modern equal temperament.

WERCKMEISTER

This temperament, invented by the organist and musical theorist Andreas Werckmeister, is recommended for performing the German musical repertoire of the late 1600s.

KIRNBERGER

This temperament, developed by Johann Philipp Kirnberger, pupil of J.S. Bach, is also suitable for playing the German baroque composers and the works of Bach.

CHAUMONT

This is based on six pure major thirds: D-F# / E-G# : D-F# / E-G# / F-A / G-B / A-C# C-E (this last one slightly flat). It can be used mainly for French music written between the end of the XVII and the beginning of the XVIII centuries.

PYTHAGOREAN

This temperament, in which the fifths were preserved perfectly pure, dates from the Middle Ages up to the 15th century, and can therefore be used for compositions of that period.

VALLOTTI

This Italian temperament by Francescantonio Vallotti was later taken up in England by Thomas Young. It can be used with effect for the 18th century Italian repertoire, but also for English music of the same period.

KELLNER

Herbert Anton, born in Prague in 1938 studied physics, mathematics and astronomy at Vienna University. His studies led him to identify in 1975 the non equal temperament of the same name used by Bach for his “Well tempered Clavier”. Suitable for German music of the XVIII century and in particular for the compositions of Bach

4. ORGAN GENERAL SETTINGS

Pressing the [SET-UP] button on the central panel gives access to the organ's general settings. The page displayed is as follows:

```
[TREMOLLO] [REVERB] [KEYBOARDS SETTING]
[INT.EQUALIZER] [ANTIPH.OUT]
```

On the version of the organ equipped with AFC reverb the SET-UP menu consists of two pages:

```
[TREMOLLO] [REVERB] [KEYBOARDS SETTING]
[INTERNAL EQUALIZER]
```

```
[EXTERNAL ANTIPHONAL OUTPUTS SETTING]
[AFC EFFECT CALIBRATION]
```

containing the following selection fields:

- **TREMOLLO:** for setting the Tremolos on each manual.
- **REVERB:** for selecting the type of reverb required. Balance between the internal reverb and the AFC reverb (only on the version with AFC reverb).
- **KEYBOARDS SETTING:** for adjusting the general parameters for the manuals and the pedal board.
- **INTERNAL EQUALIZER:** for setting the organ's internal equalizer.
- **ANTIPH. OUT / EXTERNAL ANTIPHONAL OUTPUTS SETTING:** for setting the rear outputs [ANTIPHONAL OUT].
- **AFC EFFECT CALIBRATION:** automatic calibration of the AFC reverb.

NOTE

INTERNAL EQUALIZER, ANTIPHONAL OUT and AFC EFFECT CALIBRATION functions are described in the "Advanced Manual".

To select the function required, place the cursor on the relative field using the [CURSOR] buttons and press [ENTER]. Otherwise, press [EXIT] or [SET-UP] to exit the current menu and return to the main menu page. Instead by pressing a button in a different menu it will be possible to access directly the list of functions required.

4.1 SETTING THE TREMOLO

The TREMOLO function can be used to set the modulation speed and depth of the tremolo for each manual. When the TREMOLO field is selected in the SET-UP menu, the display will show the page:

| | | | |
|-------------|-------|-------|-------|
| TREMOLO: | Choir | Great | Swell |
| Depth/Speed | 16/16 | 16/16 | 16/16 |

which shows the three manuals and, on the bottom line, the **Depth** (modulation depth) and **Speed** (modulation speed).

As the display states, the number to the left of the “/” symbol represents the Depth, while the number to the right is the Speed. To change the values use the [CURSOR] buttons to move the cursor and the encoder [VALUE].

After making all the changes required, press [ESC] to return to the SET-UP menu and to save the new settings.

4.2 SELECTING THE TYPE OF REVERB

The REVERBERATION TYPE function allows eight types of reverb to be selected, with different diffusion and propagation of the reverberated signal, which can be used to simulate the reverberation of the sound generated by the organ in different ambient settings.

As described in chap. 3, the [REVERB] potentiometer on the centre panel is used to adjust the level of reverb.

To set the type of ambient effect required, select the REVERB field in the SET-UP menu and press [ENTER] the following page will appear:

| |
|------------------------------|
| REVERBERATION type:Cathedral |
|------------------------------|

Use the encoder to select the type of reverb and press [EXIT] to save the selection and return to the SET-UP menu.

NOTE

The organ's internal reverb also affects the Orchestra voices and any incoming signals through the [INPUT] sockets on the rear panel.

VERSION OF THE ORGAN EQUIPPED WITH AFC REVERB

The AFC (Active Field Control) module developed by Yamaha Corporation is an innovative reverb system that makes use of the latest electro-acoustic technology to make certain aspects of the reverb effect more efficient and natural sounding such as the strength, spatial dimension and reflection of the sound.

To generate the reverb the AFC controls the acoustic response of the room setting in which the organ is placed and adapts the characteristics of the effect in relation to it. In this way the organ can be used in large size rooms avoiding all the undesirable effects which this type of surrounding can generate, or, on the contrary, the organ can be positioned in a very small room but the same reverb typical of a large concert hall can be achieved.

On the version of the organ equipped with AFC, in addition to selecting the type of reverb, it is also possible to adjust the balance between the internal reverb and the AFC reverb. The following page is used to do this:

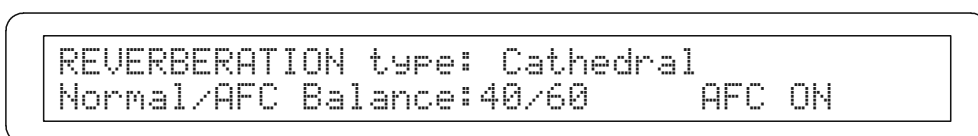

The NORMAL/AFC BALANCE parameter adjusts the balance between the two types of reverb, while the heading on the right shows the current status of the AFC system, more specifically:

- AFC ON: AFC system is turned on
- AFC BUSY: AFC system occupied and is processing data. The reverb is not currently working. Wait until “AFC ON” appears
- AFC OFF: AFC system is turned off

After making all the changes required, press [EXIT] to return to the SET-UP menu and to save the new settings.

4.3 GENERAL SETTINGS FOR THE MANUALS

The KEYBOARDS SETTING function contains four main parameter settings for the manuals and the pedal board. The first of these, which can be called up by selecting the KEYBOARDS SETTING field from the SET-UP menu, is RANKS DISTANCE (described in the “Advanced Manual”).

Now by pressing the CURSOR [▼] button the PISTON COMBINE and KEYBOARDS INVERSION parameters can be called up.

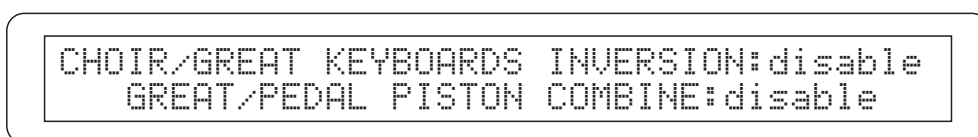

Using CHOIR/GREAT KEYBOARDS INVERSION the positions of Choir and Great can be inverted.

The GREAT/PEDAL PISTON COMBINE allows the memories of the Great to be “coupled” with those of the pedal board. In this way, when a Great memory is called up, the same pedal board memory will be activated automatically.

To set these two parameters position the cursor next to the heading on the display and use the [VALUE] encoder to select **enable** to turn it on or **disable** to turn it off.

The status of these two settings is also shown by the [CH/GT KEYB. INV.] and [GT/PD PIST. COMB.] LEDs on the centre panel (see also par. 2.2).

If you push CURSOR [▼] the display will show the last Keyboards Setting function that allows to activate or de-activate the All Swells on Swell (SWS) and Automatic Pedal in the general memories and the tremolo’s depth and speed in the general and divisional memories.



SWS, AUTOMATIC PEDAL AND TREMOLO DEPTH
AND SPEED STORED IN MEMORIES:NO

Use the [VALUE] encoder to select either **YES** to enable memorisation or **NO** to disable it.

NOTE

If memorisation of the All Swells to Swell (SWS) and Automatic Pedal (AP) settings are enabled, when the Cancel button ([C]) is pressed under the manuals these two functions will not turn off.

Now press the [EXIT] button to return to the SET-UP menu and to save the settings.

5. RECORDING AND PLAYING BACK MUSICAL PERFORMANCES

The Prestige 80 is equipped with a multitrack sequencer used to record, save to floppy disk and playback musical performances. The following are the basic directions for using these functions; a detailed description of all the sequencer functions is given in the “Advanced Manual”.

5.1 RECORDING A PERFORMANCE

To start a recording session, simply press the [RECORD] button after inserting a floppy disk in the drive. The system will read the disk and show it on the display:

```
*** Reading disk contents ***  
Please wait
```

after which the page used will appear to start recording:

```
RECORD:NEWSONG   Tempo:120   Meas: 1  
PED:REC CHR:REC  GRT:REC SWL:REC CM:REC
```

Now turn on the voices and controls required, then press [START-STOP] to start recording. The sequencer will start with the number of count-in bars (set using the metronome page, see the “Advanced Manual”) and the Led of the [START-STOP] button will flash in time with the current tempo and the Time Signature set.

To stop recording, press [START-STOP] again; the display will show the page for saving the sequence just recorded, on which the name of the .MID file that will be written to the floppy disk can be entered.

```
SEQUENCER SAVE:  
SONG:SESSION1.MID - Press ENTER to start
```

With the usual procedure, use the [CURSOR] buttons to move the cursor and the encoder to select the characters. Then press [ENTER] to save the recording or [EXIT] to abort the saving operation. Otherwise, use [RECORD] or [EXIT] to exit the sequencer function and return to the main page.

WARNING!

To make sure that existing recordings are not lost, when entering the name of the song take care not to enter a name already on the disk. In this case, the original file will be overwritten.

5.2 PLAYING BACK A PERFORMANCE

To play back a track recorded using the sequencer, insert the floppy disk in the drive and press [PLAY]. The system will proceed to read the floppy disk:

```
*** Reading disk contents ***
      Please wait
```

after which all the tracks (.MID files) saved on the disk will be displayed:

```
ERICSONG.MID SESSION1.MID RECORD_1.MID
RECORD_2.MID RECORD_3.MID
```

Use the [CURSOR] keys to select the song you wish to play and press [ENTER]. The display will show the page:

```
PLAY:SESSION1   Tempo:120   Meas: 1
PED:--- CHR:PLY GRT:PLY SWL:PLY CM:PLY
```

Press [START-STOP] to start playing back the file.

While the track is playing back the voices can also be changed and it is possible to play along with the sequencer.

Playback can be paused temporarily using the [PLAY] button.

```
PLAY:SESSION1   Tempo:120   Meas: 1
PED:PSE CHR:PSE GRT:PSE SWL:PSE CM:PSE
```

press [PLAY] again to continue.

To stop the playback, press [START-STOP] again; press [EXIT] or [PLAY] to exit the sequencer and return to the main menu.

6. VOICE LOCAL OFF

Setting a voice in Local Off mode means that it will not be played by the organ's internal sound generation system but the relative MIDI message is sent (System Exclusive) so that it can be turned on and played on a connected instrument.

To set Local Off for a voice press [S] (Set) and, keeping it down, press [C] (Cancel). All the stops will come on and the display will show the page:



```
LOCAL ON/OFF STOPS SETTINGS
*****
```

To set a voice in Local Off mode, push its stop so that the light goes out. After creating the set up required, press [S] and [C] together to save it. Accessing the Local Off setting function after this will trigger display of the status of the voices as follows:

- Light on: voice in Local On mode (sound generated internally)
- Light off: voice in Local Off mode

In normal operation, when a voice in Local Off is turned on, the stop flashes twice and then a fixed light stays on.

7. FACTORY SETTING

With the operation of the Factory Setting, all functions will return to factory setting, cancelling the changes made by the user.

To recall this procedure, press switches ,CURSOR [▲] and [▼] together, and keep them pressed down whilst switching the organ on. The following video page will appear:



```
Factory Setting in Progress
```

FCC RULES

NOTE: This equipment has been tested and found to comply with the limits for a **Class B** digital Device, pursuant to Part 15 of the FCC Rules. These limits are designed to provide reasonable protection against harmful interference in a residential installation. This equipment generates, uses and can radiate radio frequency energy and, if not installed and used in accordance with the instruction, may cause harmful interference to radio communications. However, there is no guarantee that the interference will not occur in a particular installation. If this equipment does cause harmful interference to radio or television reception, which can be determined by turning the equipment off and on, the user is encouraged to try to correct the interference by one or more of the following measures:

- Reorient or relocate the receiving antenna.
- Increase the separation between the equipment and receiver.
- Connect the equipment into an outlet on a circuit different from that to which the receiver is connected.
- Consult the dealer or an experienced Radio/TV technician for help.

The user is cautioned that any changes or modification not expressly approved by the party responsible for compliance could void the user's authority to operate the equipment.

viscount

Viscount International S.p.A.

Via Borgo n.° 68/70 – 47836 Mondaino (RN), ITALY

From Italy: TEL: 0541-981700 FAX: 0541-981052

From all other countries: TEL: +39-0541-981700 FAX: +39-0541-981052

E-MAIL: organs@viscount.it

WEB: <http://www.viscount-organs.com>

<http://www.viscount.it>